







Note: BigShot-HD 3X wide angle and the 10X lens will take longer to adjust when zooming in and zooming out as the wide angle lens covers more area. The lens adjusts to the primary focal point, then beyond it and back to the primary subject in the field of view. This is normal operation.

Contents:

1. Safety Information - considerations
2. Primary features & functions
 - 2.1. Video Conferencing Camera – rear connectivity visual
 - 2.2. Rear panel connectivity
 - 2.2.1. RS232 VISCA In interface identification
 - 2.2.2. RS232 VISCA Out interface identification
 - 2.2.3. Power Interface – please use dedicated power supply included with your BigShot-HD camera
 - 2.2.4. IR – Infrared receiver
 - 2.2.5. RS422 VISCA interface identification
 - 2.2.6. Mini USB Connection
 - 2.3. PTZ connectivity
 - 2.3.1. PTZ Connection through PC to an RS232 VISCA port on the camera
 - 2.3.2. Cascading multiple BigShot-HD cameras
 - 2.4. BigShot-HD – PTZ functions
3. BigShot-HD dial-up settings
 - 3.1. Dial-up address table
 - 3.2. Dial-up Infrared address settings
 - 3.3. Communication protocol – dial-up cable setting
 - 3.4. Communication mode – dial-up cable setting
4. Remote control functionality

1. Safety Information- considerations

-  Before installing your BigShot-HD camera please read instructions carefully.
-  Handle the BigShot-HD camera carefully to avoid damage to your optics.
-  Avoid exceeding the camera operating limits – temperature, humidity power etc..
-  Please do not dismantle BigShot-HD cameras you will void the warranty.
-  Please do not use harsh cleaners on the exterior casing of BigShot-HD cameras.
-  Please use a soft cloth or lens pad to wipe the lens with.

2. Primary features & functions

2.1. Video Conferencing Camera – rear connectivity visual:



1. RS232 In
2. RS232 Out
3. DC12V-1.2A power supply
4. IR
5. RS422 Interface
6. Mini USB connection

2.2. Rear panel connectivity - Video Conference Interface functionality – pictured below:

2.2.1 ①VISCA RS-232C IN interface identifier

Serial number	Function
1	DTR IN
2	DSR IN
3	TXD IN
4	GND
5	RXD IN
6	GND
7	No Connection
8	No Connection

VISCA RS-232C IN

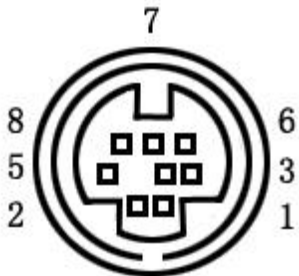

2.2.2 ②VISCA RS-232C OUT: interface identifier

Serial Number	Function
1	DTR Out
2	DSR Out
3	TXD Out
4	GND
5	RXD Out
6	GND
7	No Connection
8	No Connection

VISCA RS-232C OUT

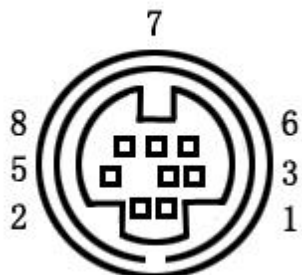

2.2.3. Power Interface – please use dedicated power supply included with your BigShot-HD camera

2.2.4. IR – Infrared receiver

2.2.5. RS422 VISCA interface identification

Serial Number	Function
1	TXD IN+
2	TXD IN-
3	RXD IN- (485B)
4	RXD IN+ (485A)
5	GND

VISCA RS-422

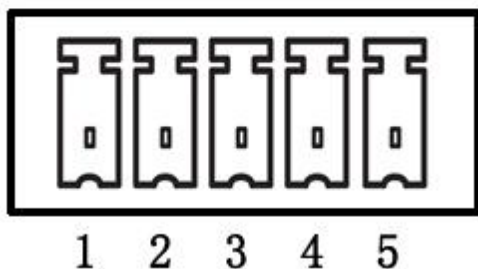

2.2.6. Mini USB Connection – a 15 foot USB to mini USB cable is included with each BigShot-HD

2.3. PTZ connectivity

2.3.1. PTZ Connection through PC to an RS232 VISCA port on the camera:

9 pin connection:

Port Function	Windows D-Sub 9 pin
1 – DTR IN	1. CD
2 – DSR IN	2. RXD
3 – TXD IN	3. TXD
4 – GND	4. DTR
5 – RXD IN	5. GND
6 – GND	6. DSR
7 – N.C.	7. RTS
8 – N.C.	8. CTS
	9. RI

25 pin connection

Port Function	Windows D-Sub 25 pin
1 – DTR IN	1 – FG
2 – DSR IN	2 – TXD
3 – TXD IN	3 – RXD
4 – GND	4 – RTS
5 – RXD IN	5 – CTS
6 – GND	6 – DSR
7 – N.C.	7 – GND
8 – N.C.	20 – DTR

2.3.2. Cascading multiple BigShot-HD cameras – Through the cascade method of Video Conferencing you can connect multiple cameras together and you can separately control each camera – the cascade method is configured with the following settings:

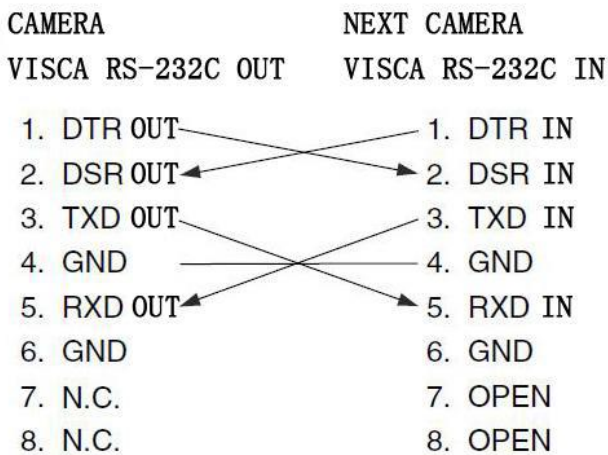

- 2.4. BigShot-HD – PTZ functions
- 360 degree continuous rotation and a 90 degree vertical rotation.
 - 10 Presets can be controlled with positioning accuracy up to +0.015 degrees. To position a preset – Pan, Tilt, Zoom to desired location in the room and press the preset button then the number (1 through 10) that you would like to keep that setting at.
 - You can reboot the PTZ camera by pressing the reset button and it will restore all default functions.
 - Built-in multi-protocol decoder – set the baud rate and camera address of each BigShot-HD through the dip switch on the bottom of the camera. Control the signal through the dip switch to choose RS-485 or RS232C for transmission.
 - Video output is USB – there are no drivers required. “plug & play” operation

3. BigShot-HD dial-up settings

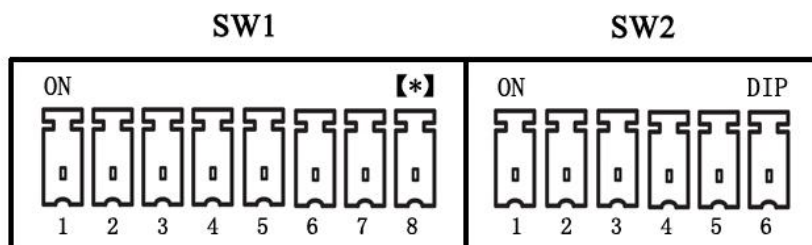

3.1. Dial-up address table

SW1 dial-up switch statue (1-8 bit)

Address	Dip – 1	Dip – 2	Dip – 3	Dip – 4	Dip – 5	Dip – 6	Dip – 7	Dip – 8
1	1	0	0	0	0	0	0	0
2	0	1	0	0	0	0	0	0
3	1	1	0	0	0	0	0	0
4	0	0	1	0	0	0	0	0
5	1	0	1	0	0	0	0	0
...								
255	1	1	1	1	1	1	1	1

Note: Broadcast address: if the address is 255 for that keyboard setting, then you can control any video conferencing address.

Test address: If the BigShot-HD camera address setting is 0, then any address can control the camera that you

3.2. Dial-up Infrared address settings

IR Switch - choose	SW (1-2 bit)	Status of dial switch
	Dip – 1	Dip – 2
0	Off	Off
1	On	Off
2	Off	On
3	On	On

Note: If the dial-up of the infrared receive address is 0 (zero)n then any address of the infrared remote control can control the camera.

3.3. Communication protocol – dial-up cable setting

protocol	SW2 (3-4bit) status of dial-up	
DIP-3	DIP-4	
PELCO_P	OFF	OFF
PELCO_D	OFF	ON
VISCA (default)	ON	ON

3.4. Communication mode – dial-up cable setting

SW2(5-6bit) status of dial-up switch			
DIP-5	BAND RATE	DIP-6	SWITCH
OFF	4800bps	OFF	RS-422
ON	9600bps	ON	RS-232C

4. Remote control functionality

Instructions for using the remote control:

- # 3 power on/off button
- # 4 select the camera you want 1 through 4 camera (note: you can control 4 BigShot-HD cameras with one remote)
- # 6 Preset control keys – move to the position that you would like to save then press Preset and the number that you would like the respective preset to correspond with. You can press "reset" to restore original settings.
- # 8 Invert image for desktop or ceiling mount - press this to "invert" the image.
- # 9 controls the Pan-tilt function.
- # 10 controls the pan-tilt rotate speed.

